

ASSEMBLY INSTRUCTION

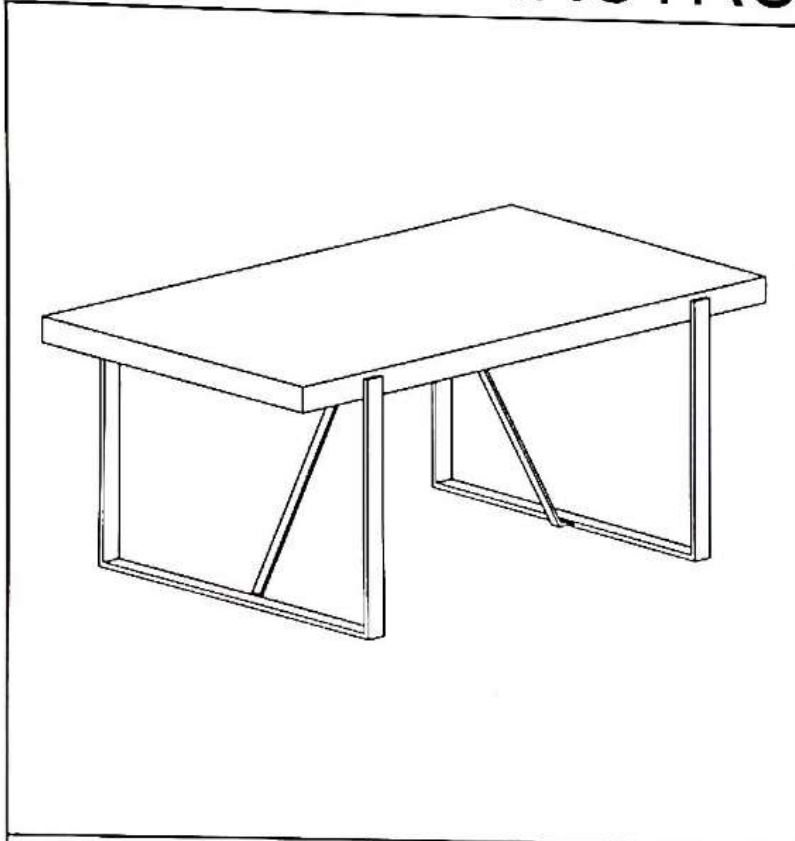

PART LIST

A*8pcs

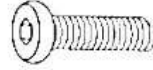

M8x40mm

B*4pcs

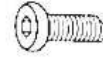

M8x35mm

C*4pcs



M6x20mm

D*4pcs



M6x15mm

E*12pcs

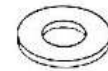

M8x18mm

F*12pcs



M8x18mm

G*2pcs

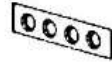

90*15mm

H*1pcs



M5

I*1pcs



M4

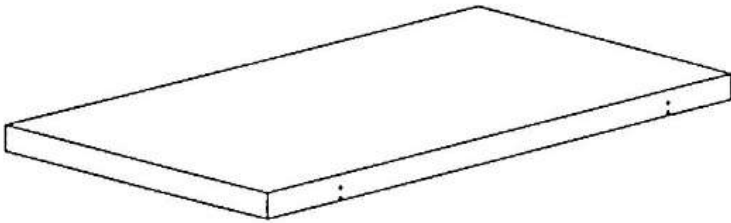

P1x1pc

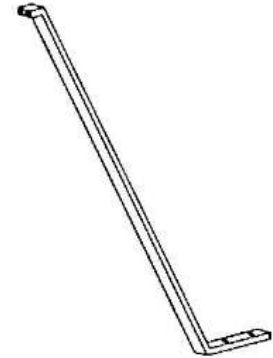

P2x2pc

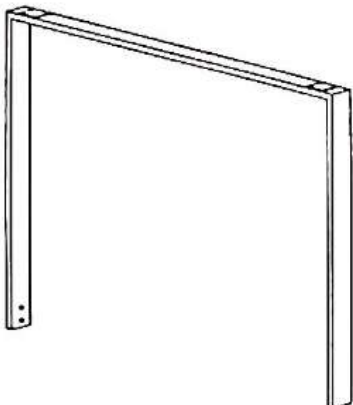

P3x2pc

ASSEMBLY INSTRUCTION

1

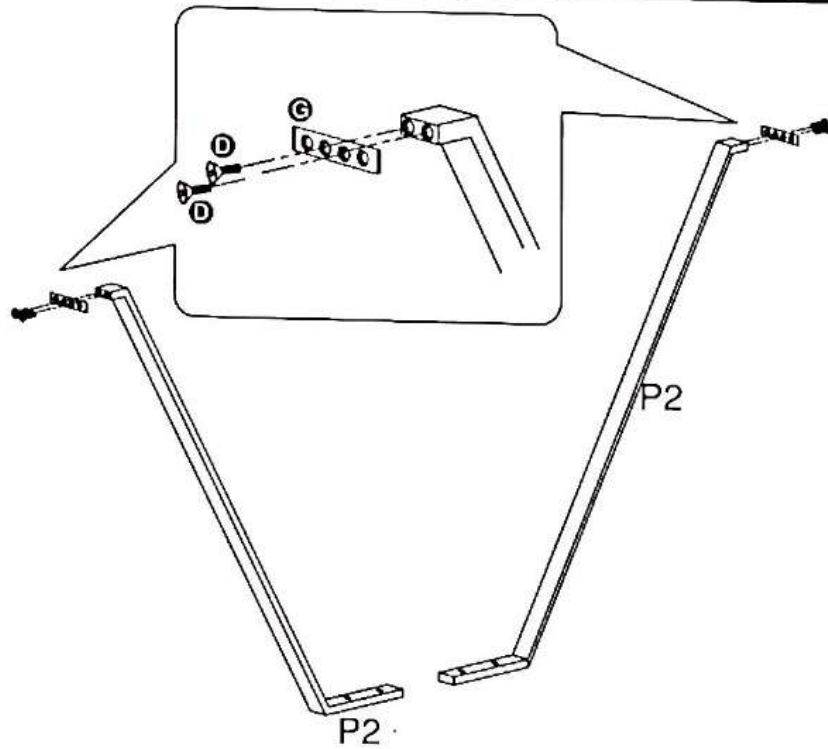

2

