

ASSEMBLY INSTRUCTION

A



M8x25

x16

B



M8

x16

C



x1

STEP 1

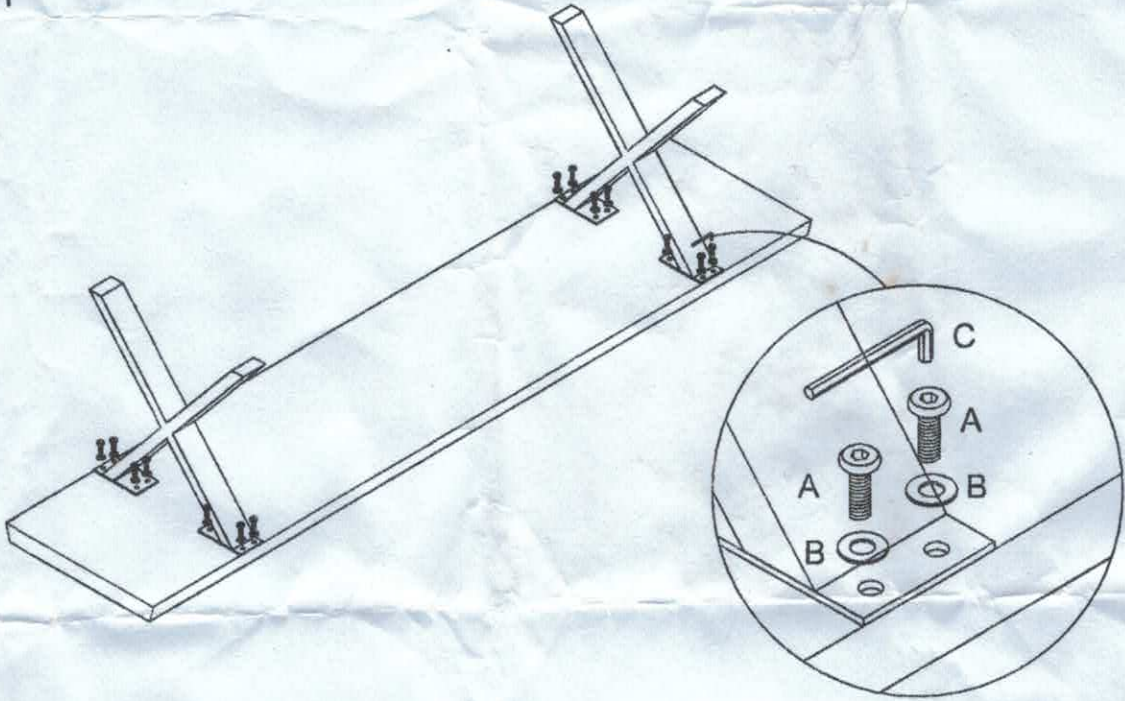

STEP 2

