

ifurniture

Better, Cheaper, Smarter!

ifurniture.ca

ifurniture.co.nz

SKU: **266--349**

BROOKE 120 Coat Hanger & Shoe Rack

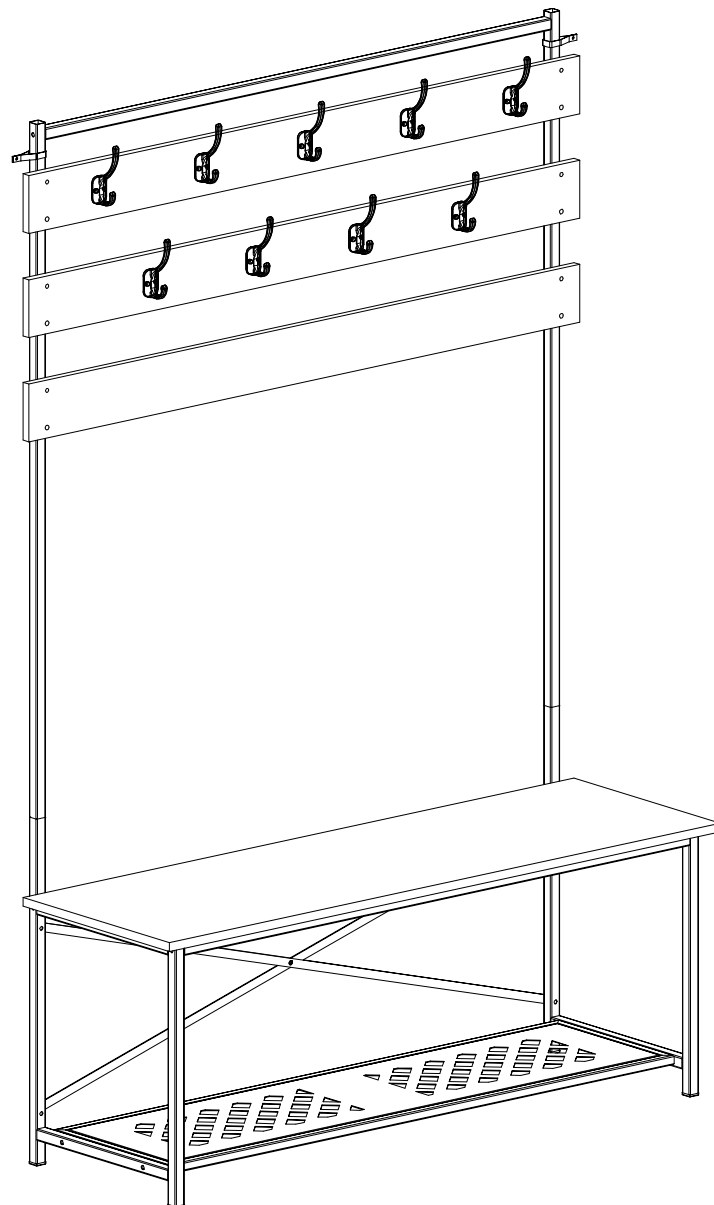



WARNING

Serious or fatal crushing injuries can occur from furniture tip-over. To help prevent tip-over.

- Place heaviest items in the lowest drawers.
- Do not set TVs or other heavy objects on the top of this product .
- Never allow children to climb or hang on drawer, door, or shelves.
- Never open more than one drawer at a time.
- Use of tip-over restraints, only reduces, but does not eliminate, the risk of tip-over.

MAINTENANCE TIPS

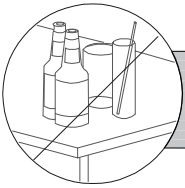

Avoid liquid spraying or infiltrating on the product surface.

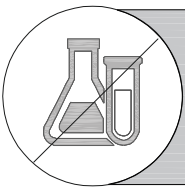

Never use chemical cleaning products. They can damage the finish. For cleaning, use only a slightly damp cloth and wipe dry.

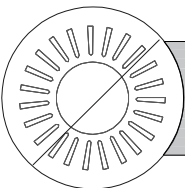

To avoid dulling of finish, do not place furniture in direct sunlight

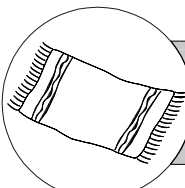

Do not put plastic or rubber rings under appliances. Use cloth or felt protectors.

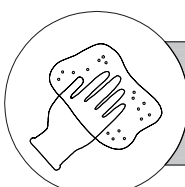

To clean, use a soft or slightly damp cloth, then wipe with a clean, dry cloth.

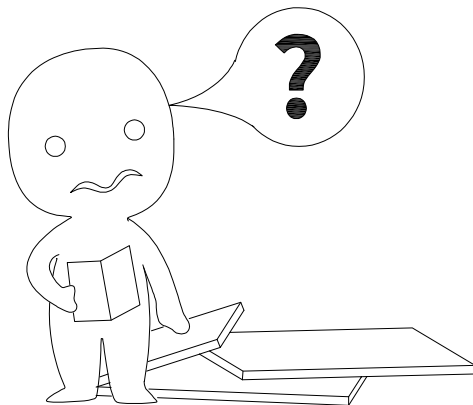
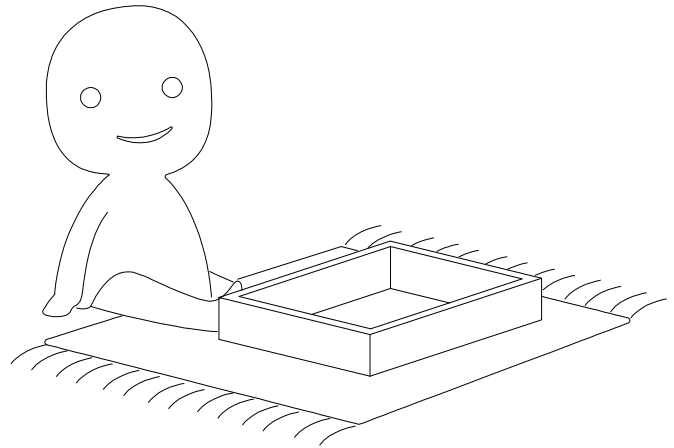
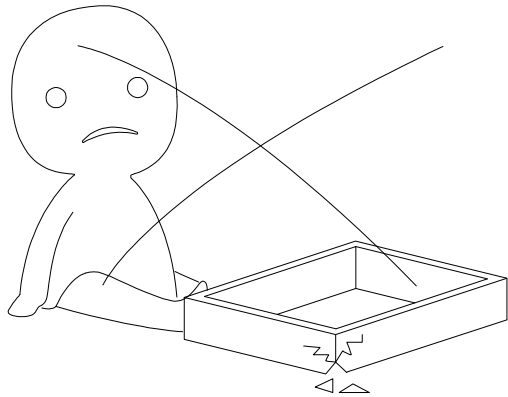
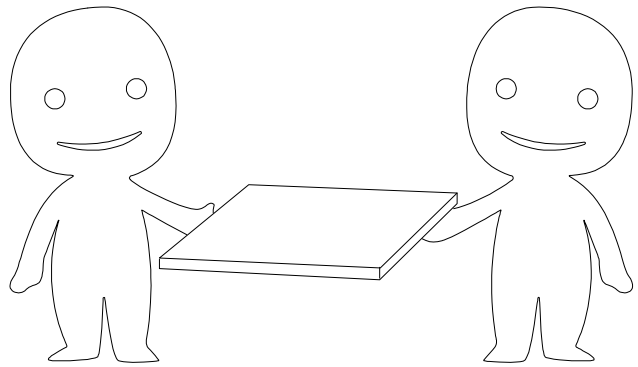
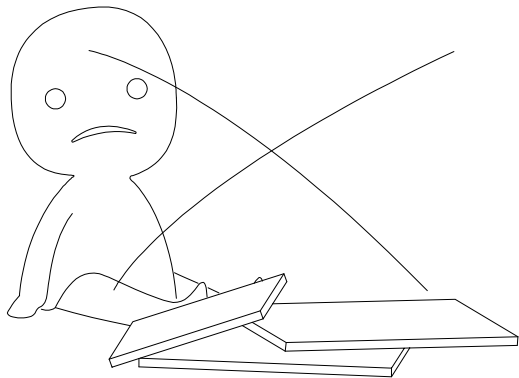
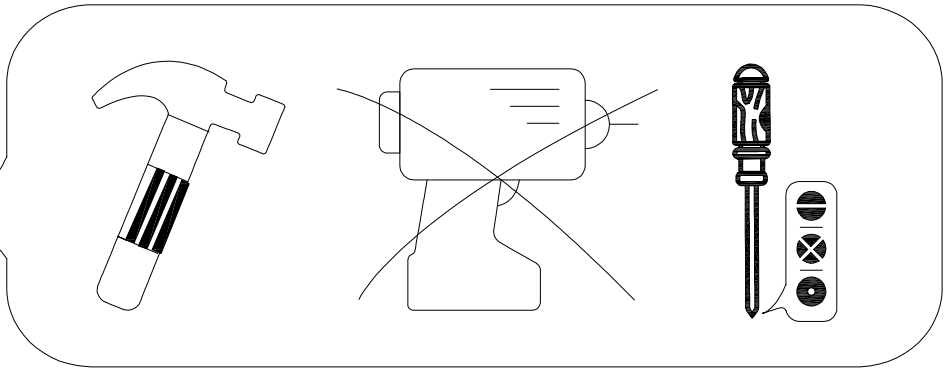
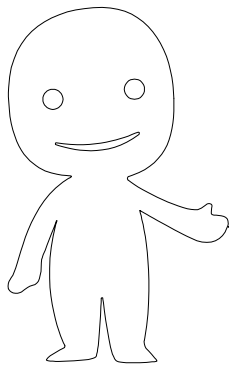









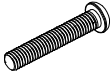

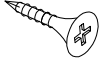
GB

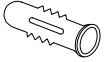
Safety information

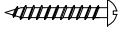
- Important information
- Please read closely and carefully
- Save this information

Hardware List/Hardwareliste

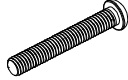
						
18 x A	5 x B	4 x C	18 x D	21 x E	6 x F	2 x G
						
2 x H	2 x I	2 x J	9 x K	1 x L	1 x M	4 x N

Parts List/Teileliste

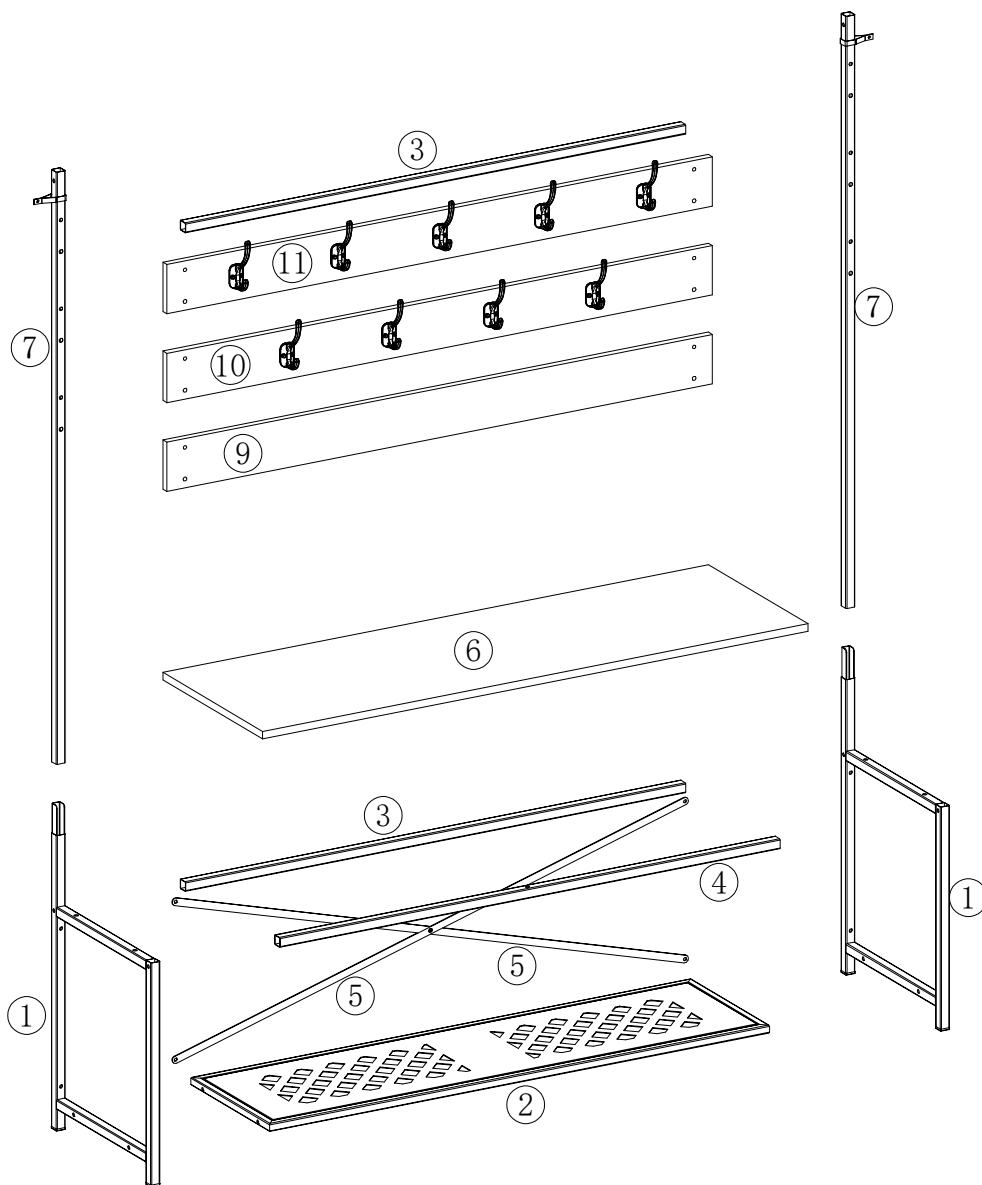

STEP 1

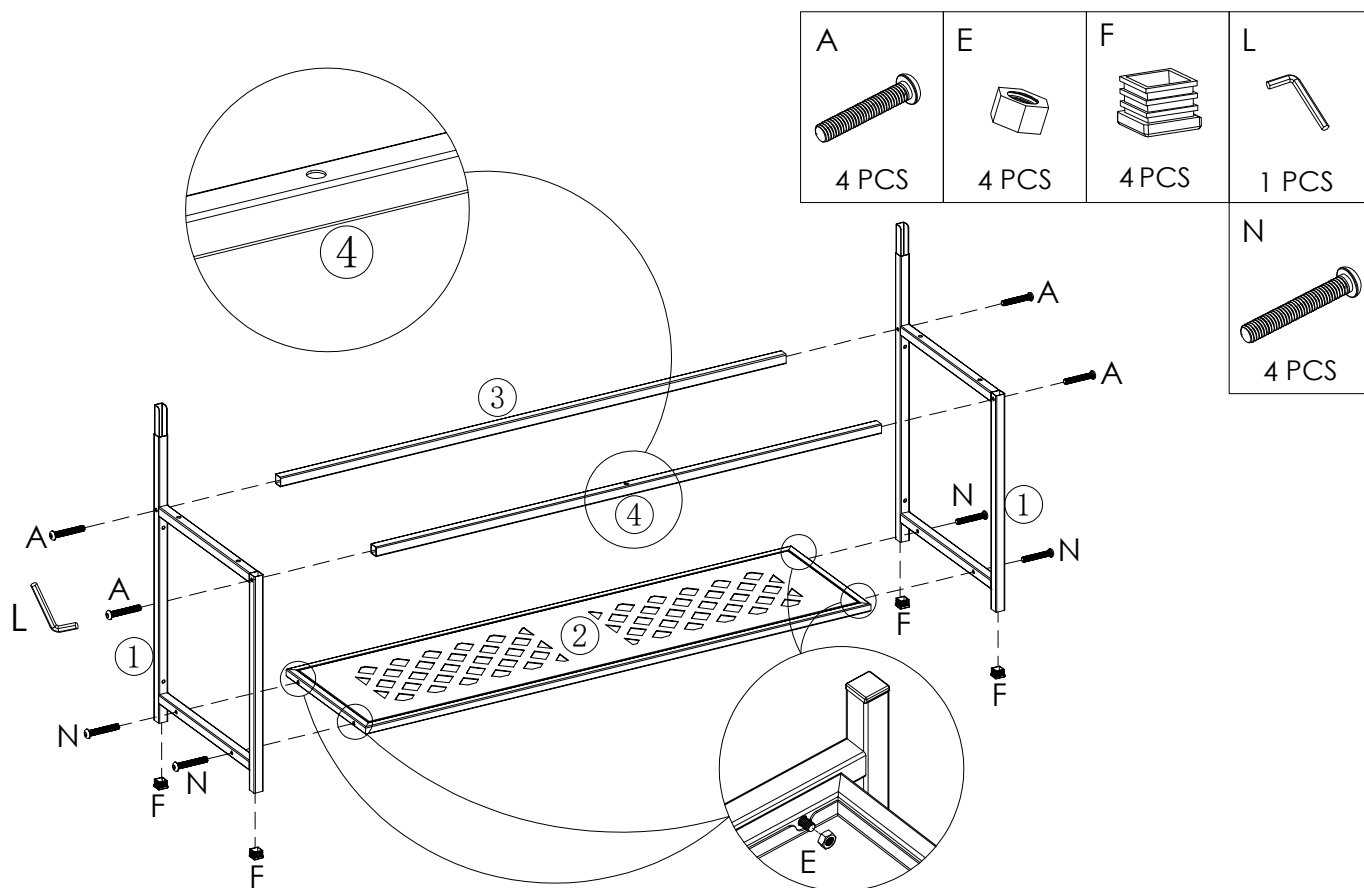

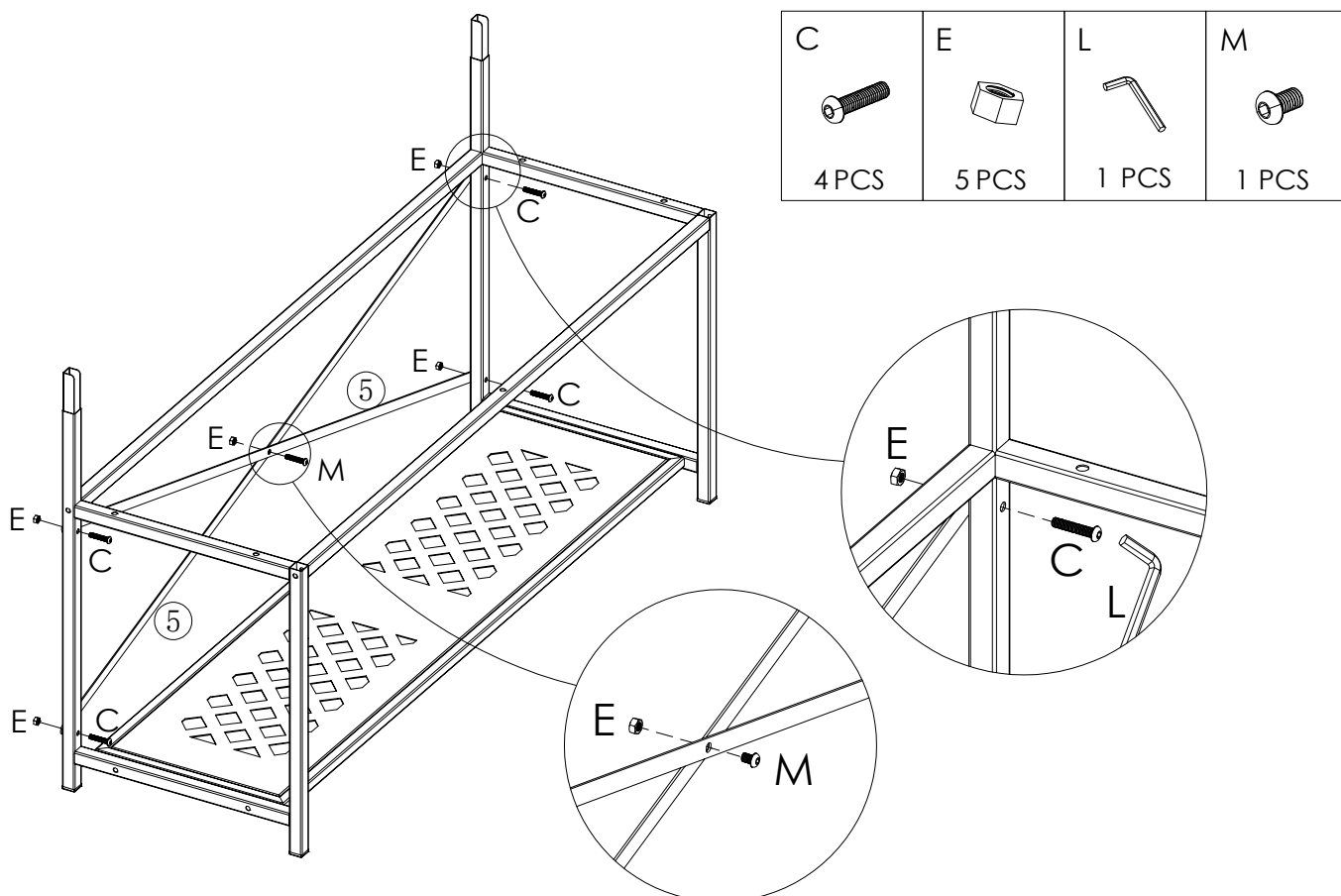

STEP 2



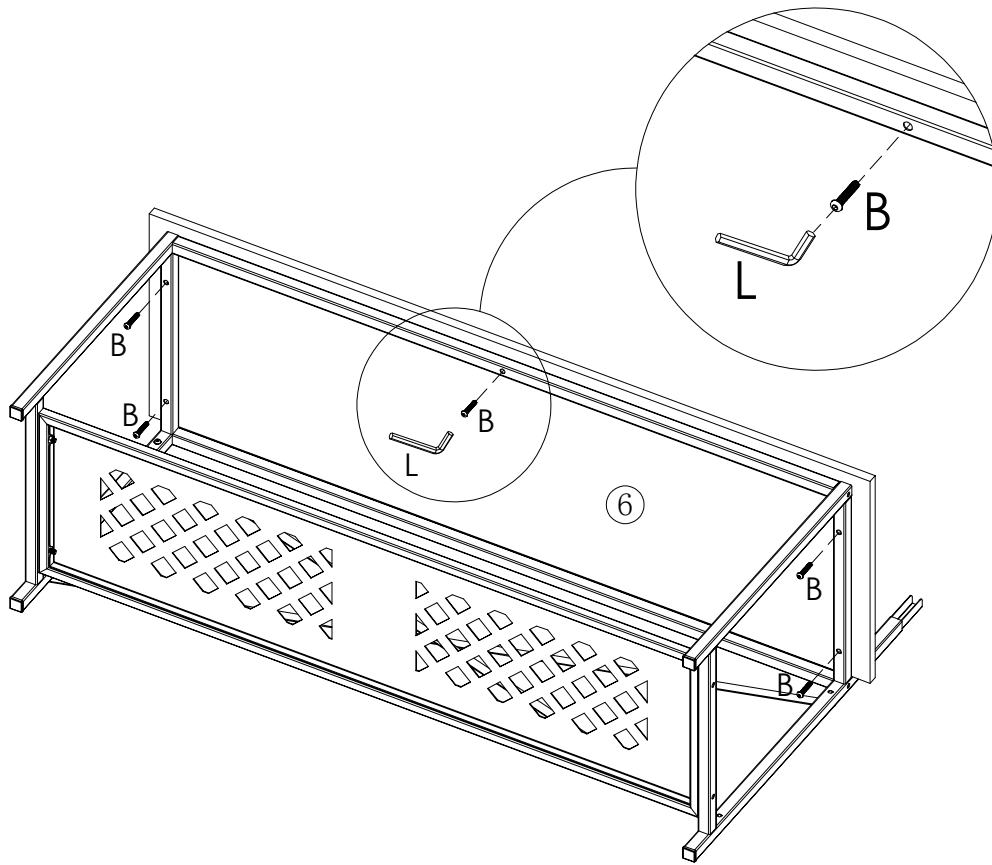



STEP 3

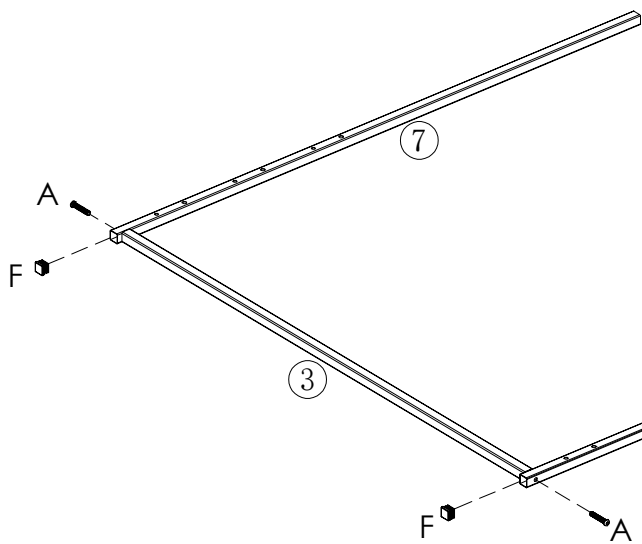

B	L
	
5 PCS	1 PCS

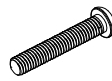
STEP 4



A	D	F	K
			
2 PCS	18 PCS	2 PCS	9 PCS

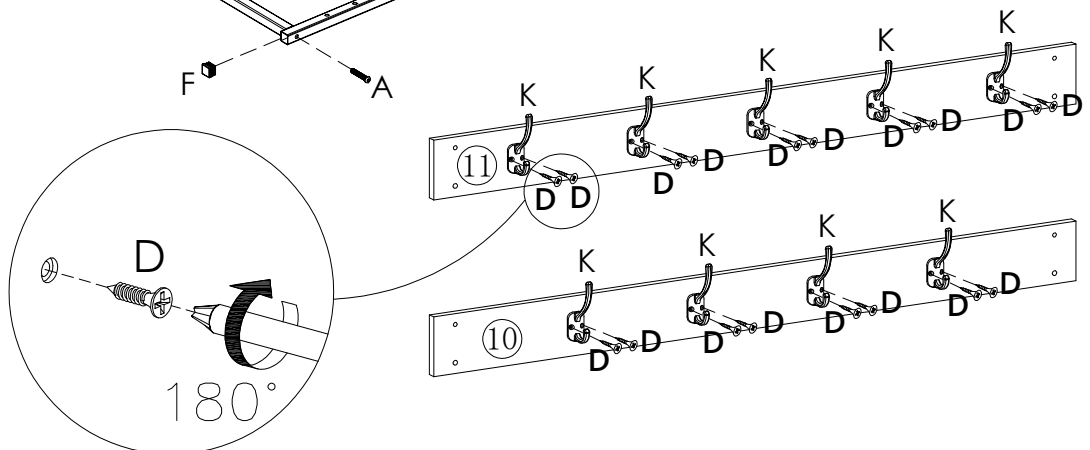

STEP 5

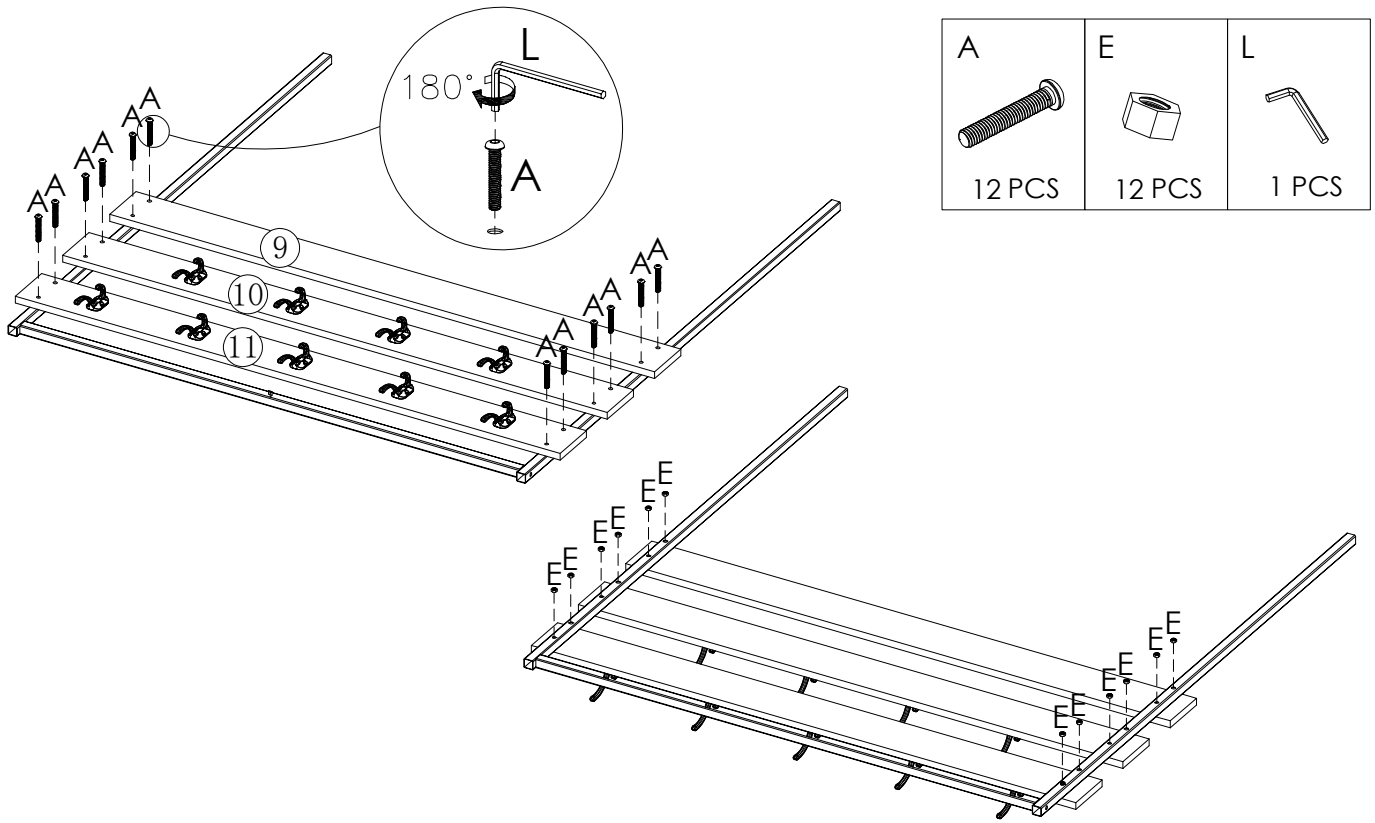

STEP 6

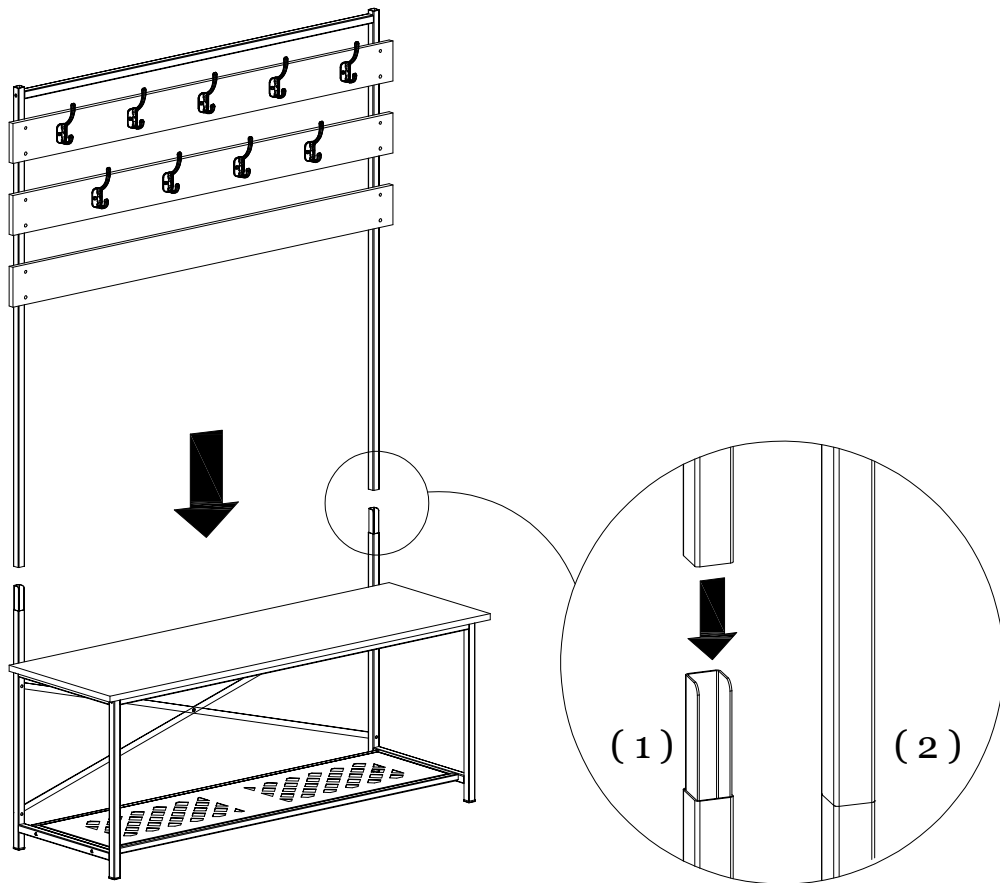

STEP 7

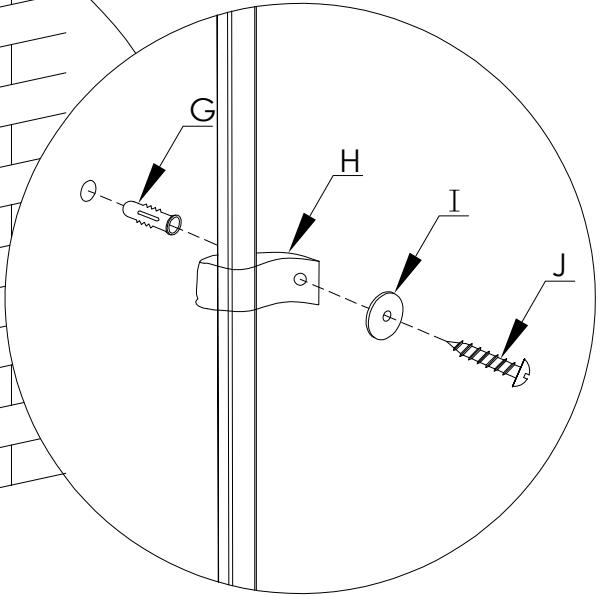
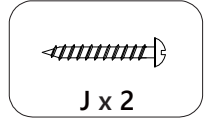
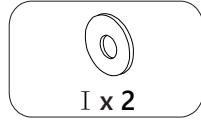
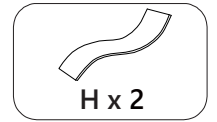
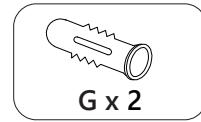
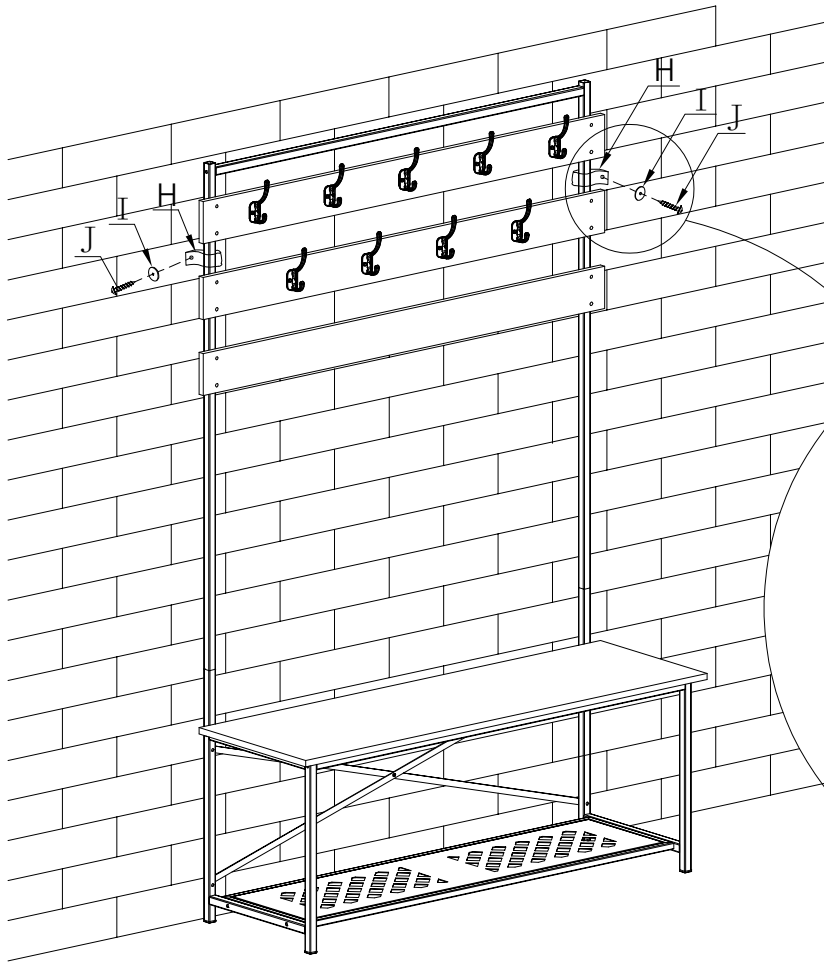

GB Safety information

Important information
Please read closely and carefully
Save this information



IMPORTANT. It is imperative that the furniture be installed according to instructions by someone properly qualified to complete the task. Installation of electrical or plumbing fixtures should only be performed by trained professionals.

The furniture must be anchored to the wall to prevent it from tipping over. Improper installation or failure to use wall fasteners can prevent the item from functioning properly and may cause damage and/or severe injury.

Wall fasteners are not included because of the large variety of walls and wall materials. Please ask a specialized dealer for wall fasteners appropriate to your specific needs. You are responsible for anchoring the items to the wall and for the materials used for that purpose.

Please observe the maximum load capacity as specified in the assembly instructions. Keep the bag containing the fittings, the fittings themselves and other packaging material out of reach of babies and children. The small parts can be swallowed and therefore pose a choking hazard.

Failure to follow handling, operation or assembly instructions, exchanging components, making changes to the product or using materials which differ from the original parts will result in voiding all liability claims and warranties. GERMANIA accepts no liability for personal or material damage due to improper installation or failure to properly anchor the item to the wall. We assume no liability as manufacturer for excessive loads placed on a unit by individuals, playing children or other causes.

Four shops address as below:



268 Neilson Street, Onehunga, Auckland.



63-65 Maki Street, Westgate, Auckland.



554 Te Rapa Road, Hamilton



447 Blenheim Rd, Upper Riccarton,
Christchurch