

Instruction Manual

6-Drawer Dresser SHX12077

SAFETY WALL STRAP INSTALLATION

Note: Safety Metal kit (#14) must be installed to prevent tipping, damage and/or injury.





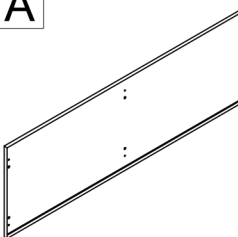
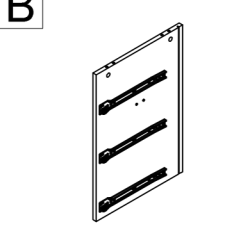
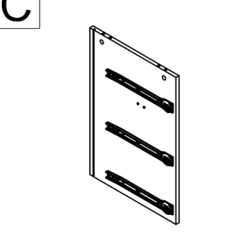
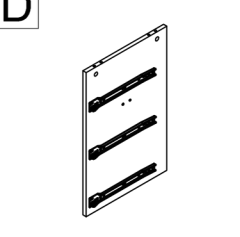
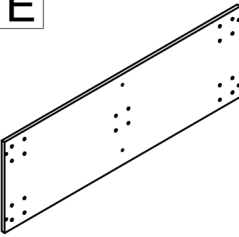
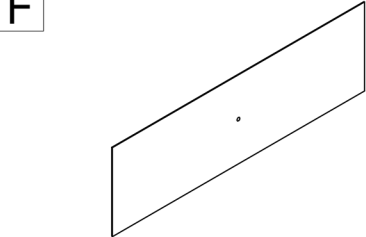
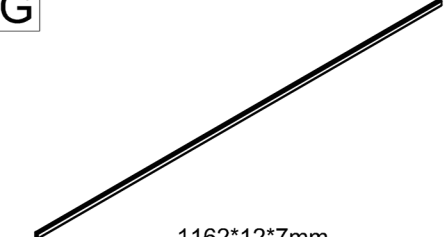
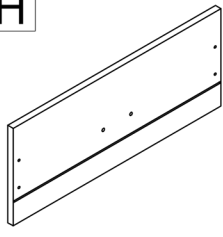
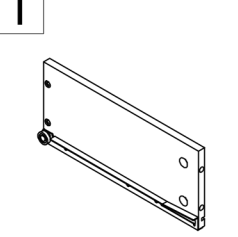
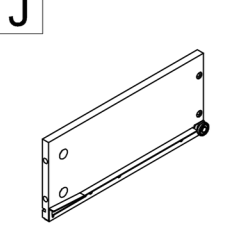
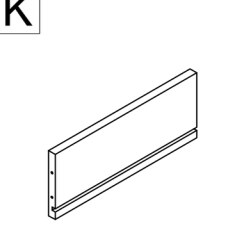
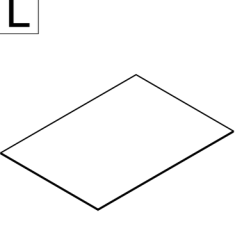
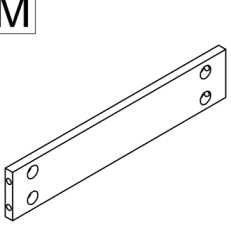







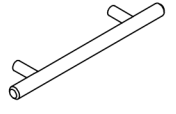

PART LIST

				
<p>Top Panel 1 PC</p>	<p>Left Panel 1 PC</p>	<p>Right Panel 1 PC</p>	<p>Partition Panel 1 PC</p>	<p>Bottom Panel 1 PC</p>
		 1162*12*7mm		
<p>Back Panel 2 PCS</p>		<p>Back Plastic Strip 1 PC</p>		<p>Drawer Front Panel 6 PCS</p>
				
<p>Drawer Left Panel 6 PCS</p>	<p>Drawer Right Panel 6 PCS</p>	<p>Drawer Back Panel 6 PCS</p>	<p>Drawer Bottom Panel 6 PCS</p>	<p>Center Rail 2 PCS</p>

SAFETY WALL STRAP INSTALLATION

Note: Safety Metal kit (#14) must be installed to prevent tipping, damage and/or injury.

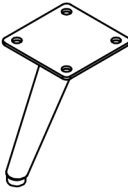
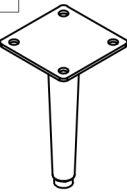
HARDWARE LIST

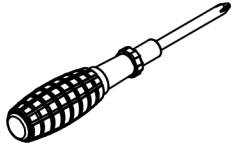
#1  Ø5*40mm	#2  Ø6*30mm	#3  Ø3*30mm	#4  Ø6*35mm	#5  Ø15*9mm
Screw 6 PCS (Extra 1)	Wood Dowel 12PCS (Extra 2)	Screw 24PCS (Extra 2)	Cam-bolt 38PCS (Extra 3)	Cam-lock 38PCS(Extra 3)
#6  150*32*Ø12mm	#7  M4*20mm	#8  14*10mm	#9  Ø3.5*15mm	#10  M6*10mm
Handle 6 PCS	Round Head Bolt 12 PCS (Extra 2)	Back Bracket 8 PCS (Extra 2)	Screw 10 PCS (Extra 2)	Bolt 20 PCS (Extra 2)
#11  4mm	#12 	#13 	#14 	
Allen Wrench 1 PC	Leg 4 PCS	Center Leg 1 PC	Safety Metal Kit 1 SET	Phillips Screwdriver 1 PC

SAFETY WALL STRAP INSTALLATION

Note: Safety Metal kit (#14) must be installed to prevent tipping, damage and/or injury.

ASSEMBLY OVERVIEW

SAFETY WALL STRAP INSTALLATION

Note: Safety Metal kit (#14) must be installed to prevent tipping, damage and/or injury.

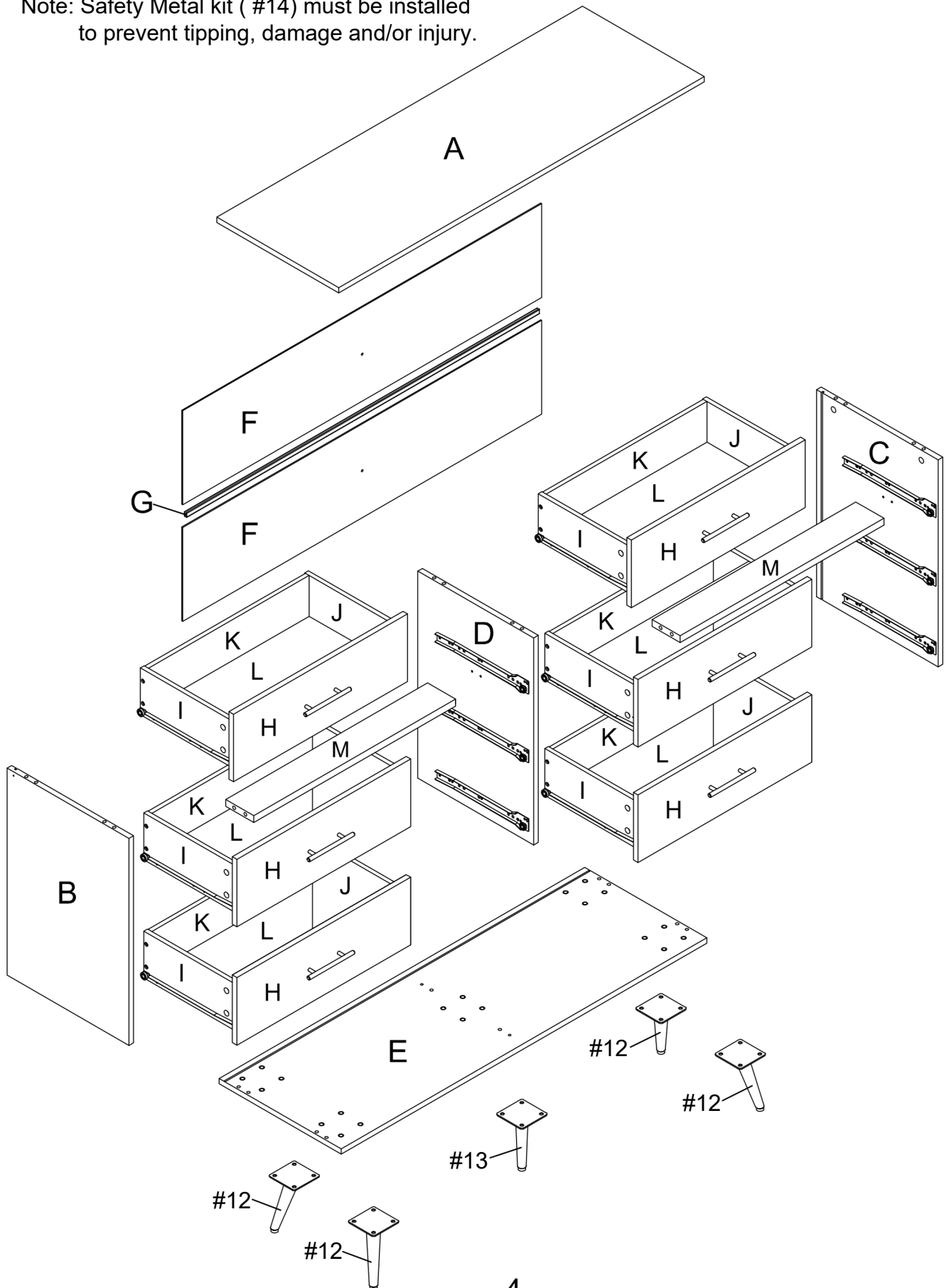

Instructions For Fastening CAM-BOLT and CAM-LOCK

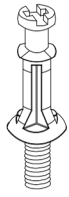

CAM-BOLT



CAM-LOCK

Tools Required

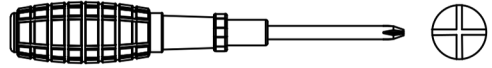

INSERTING AND TIGHTENING CAM-BOLT

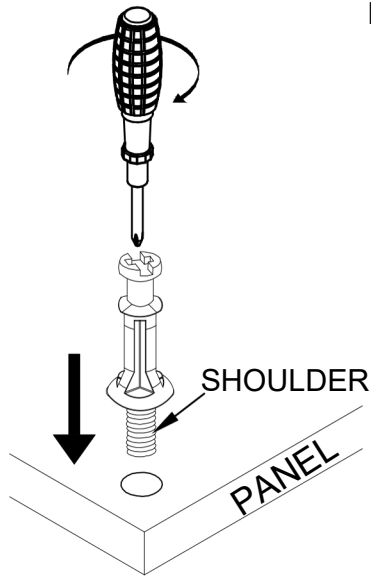

Place Cam-bolt on pre-drilled hole and screw in vertically

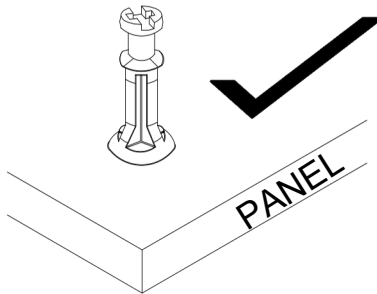

Shoulder is flushed (on the same level) with the panel.

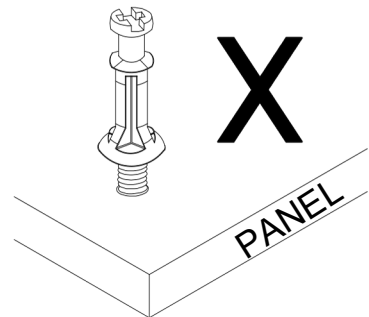

Shoulder is above the panel.

Place Cam-bolt on the designated pre-drilled holes on the panel. Use a Phillips Screwdriver to screw-in Cam-bolt vertically until shoulder is flushed (on the same level) with panel.

INSERTING CAM-LOCK

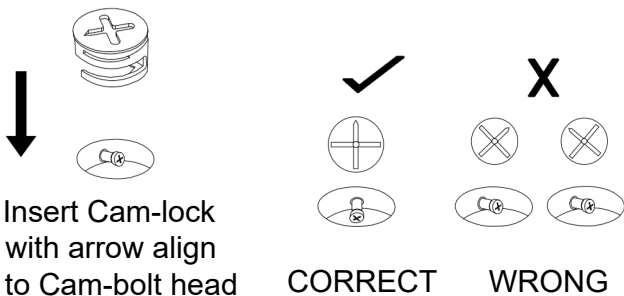

Insert Cam-lock with arrow align to Cam-bolt head

CORRECT

WRONG

Align the arrow on the Cam-lock to the Cam-bolt head and insert the Cam-lock. Ensure Cam-lock is fully inserted.

TIGHTENING CAM-LOCK

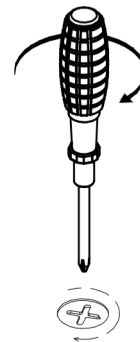

Use a Flat-head Screwdriver to turn Camlock clockwise so it locks onto the head of the Cam-bolt. Turn until it is snug (about 3/4ths of a turn) -- over-tightening could damage Cam-lock or/and Cam-bolt.

Step 1.

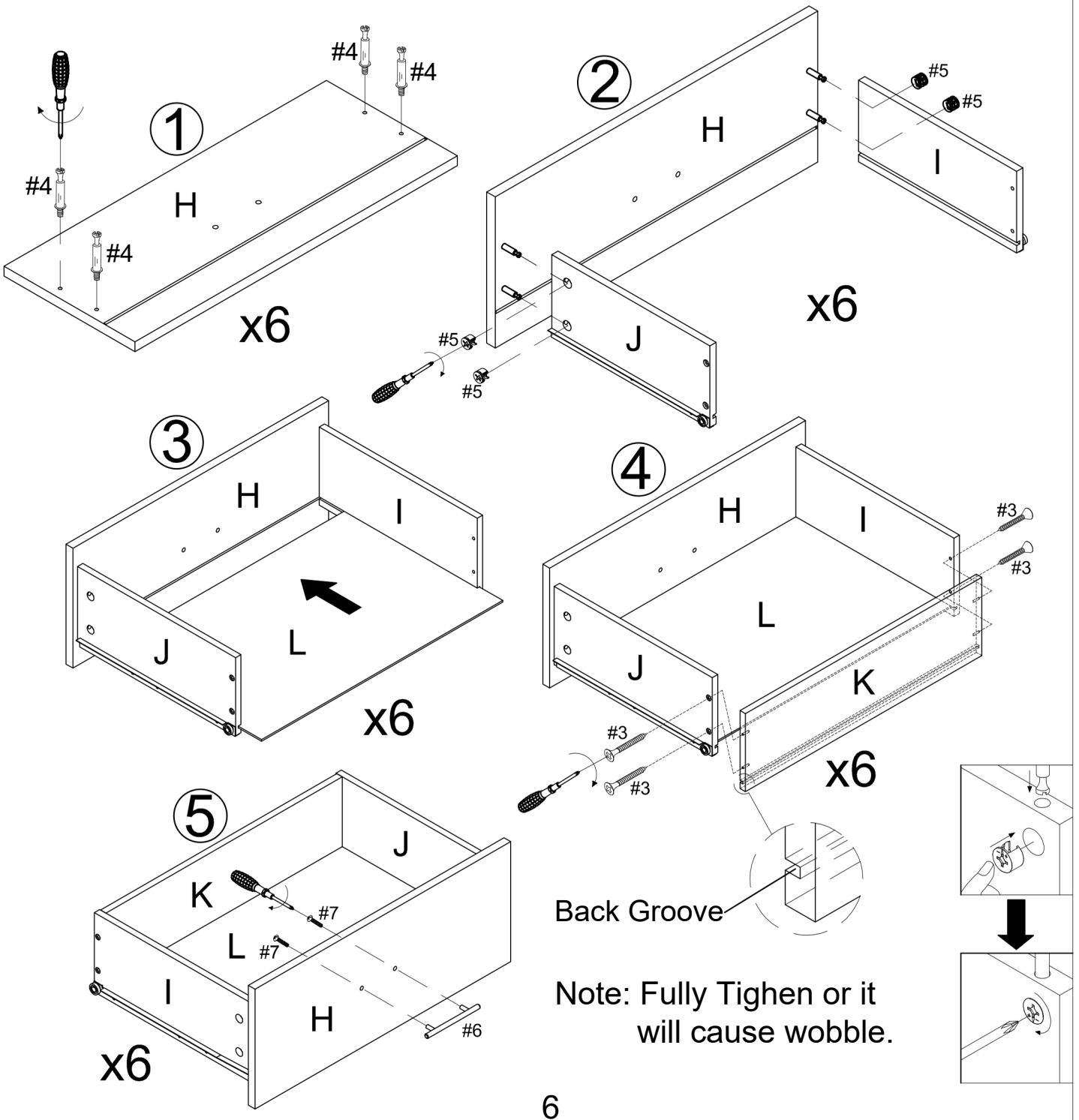
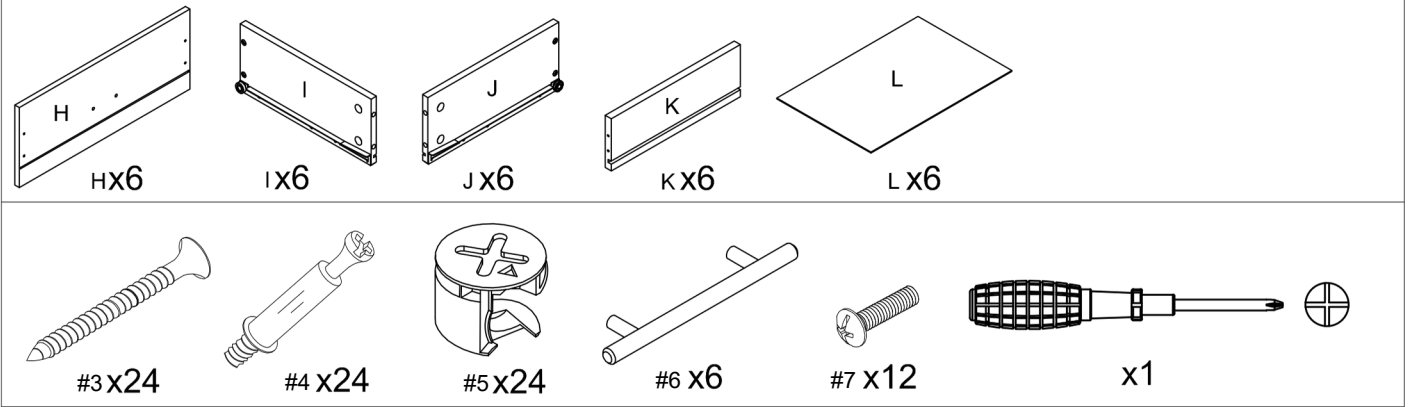

Step 2.

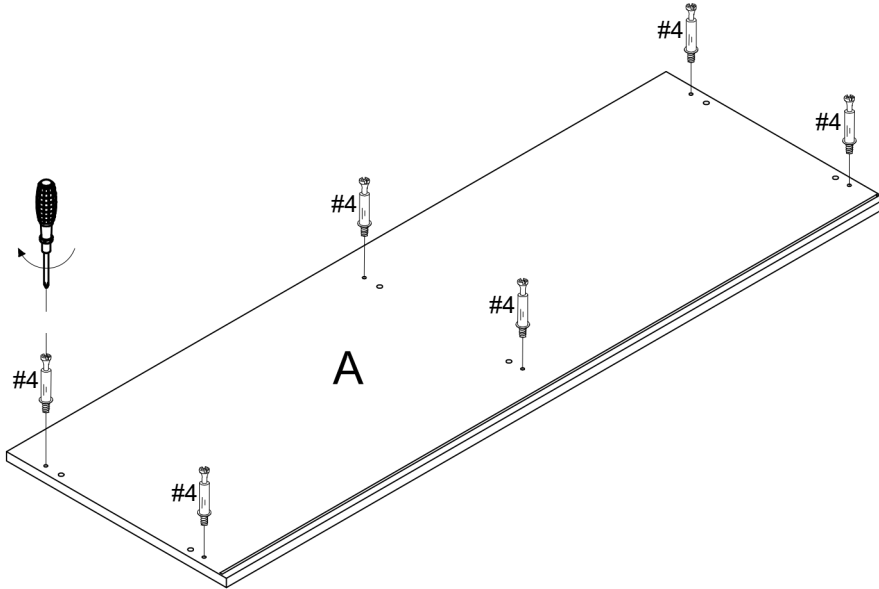
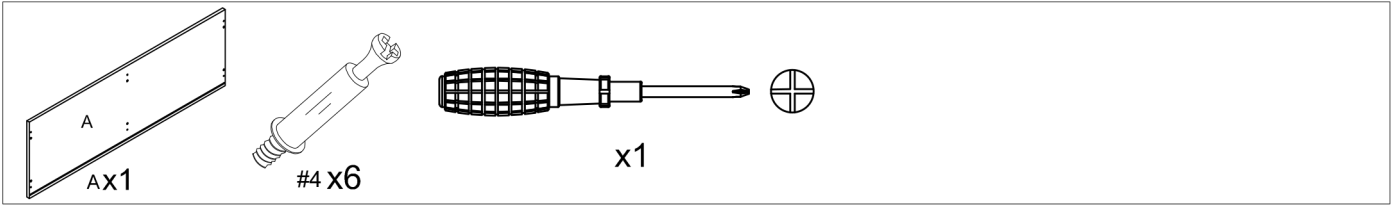

Step 3.

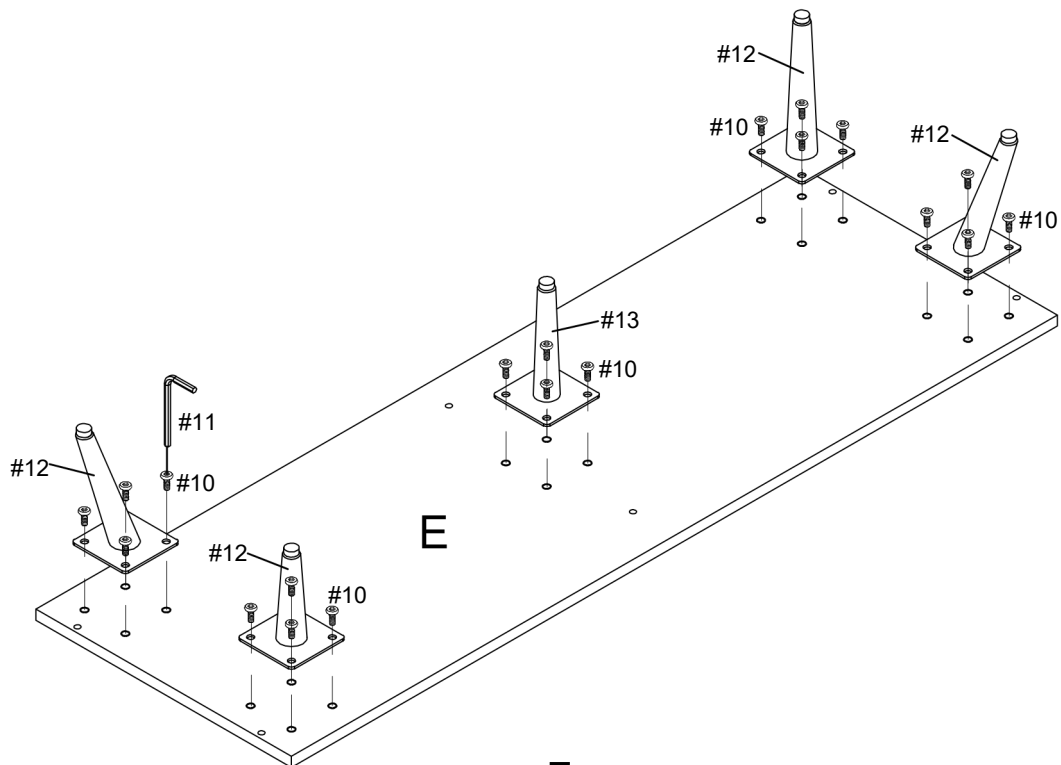
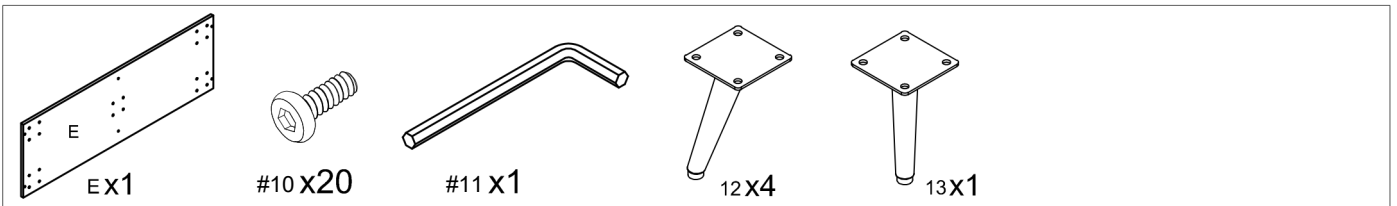

Step 4.

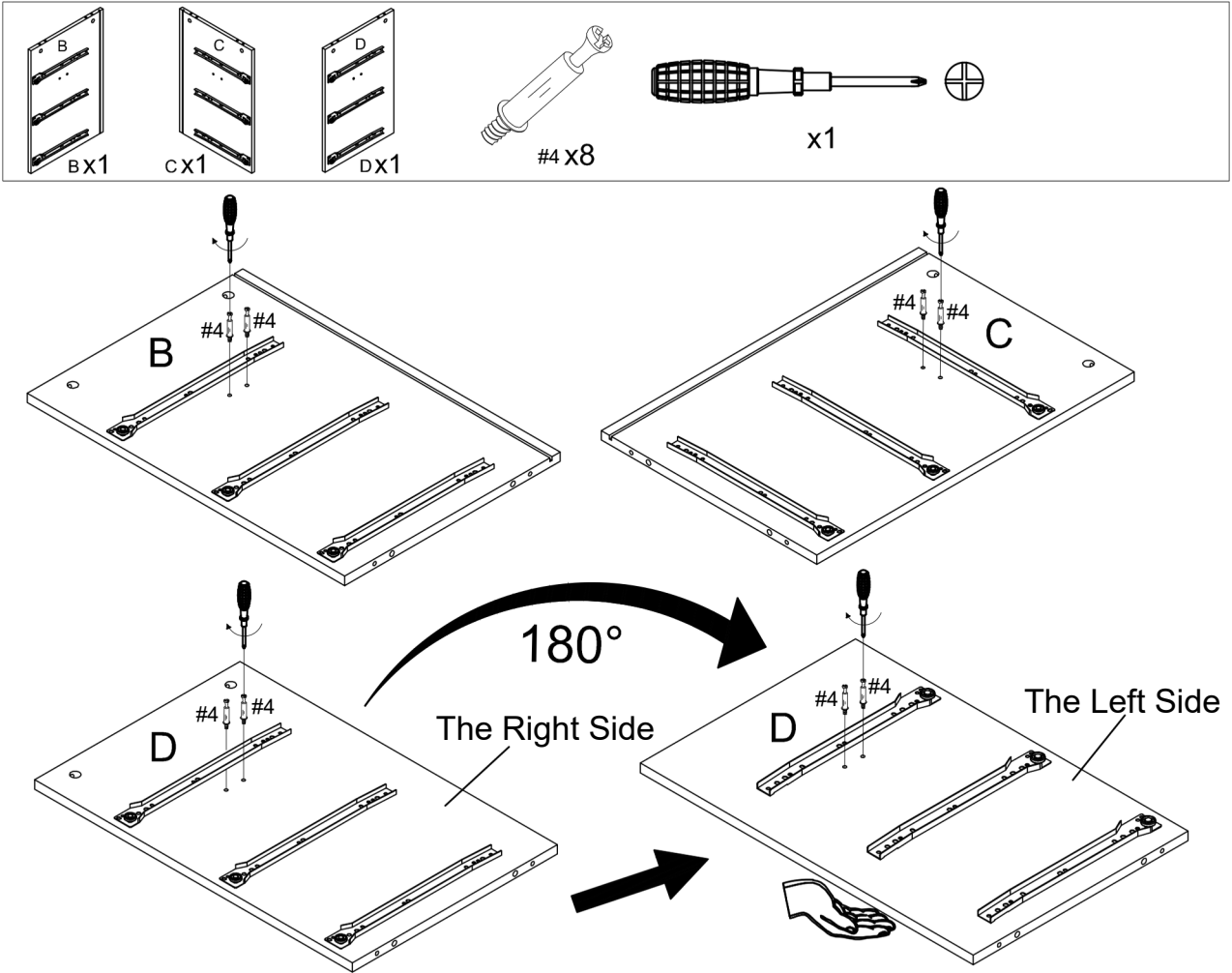

Step 5.

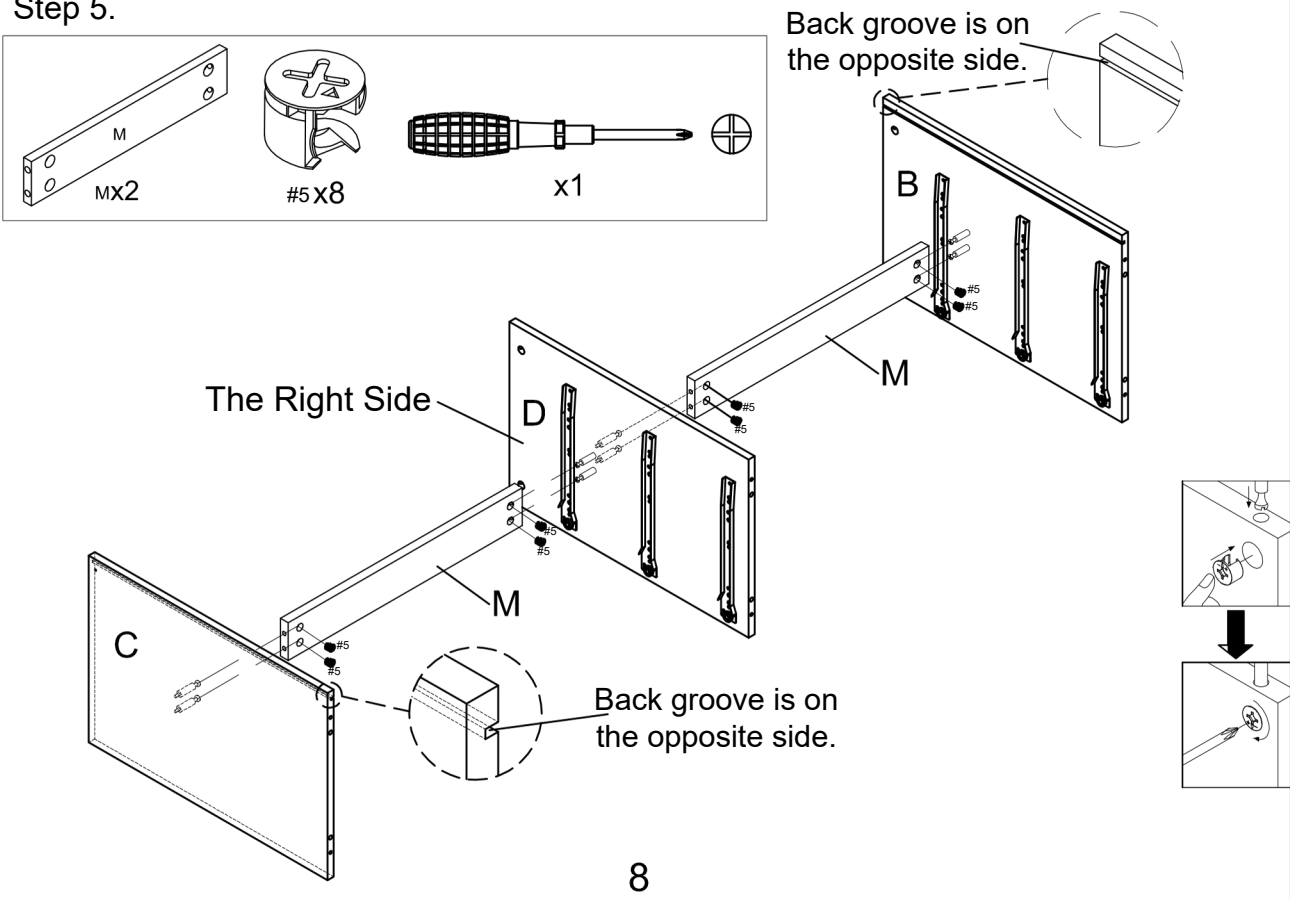

Step 6.

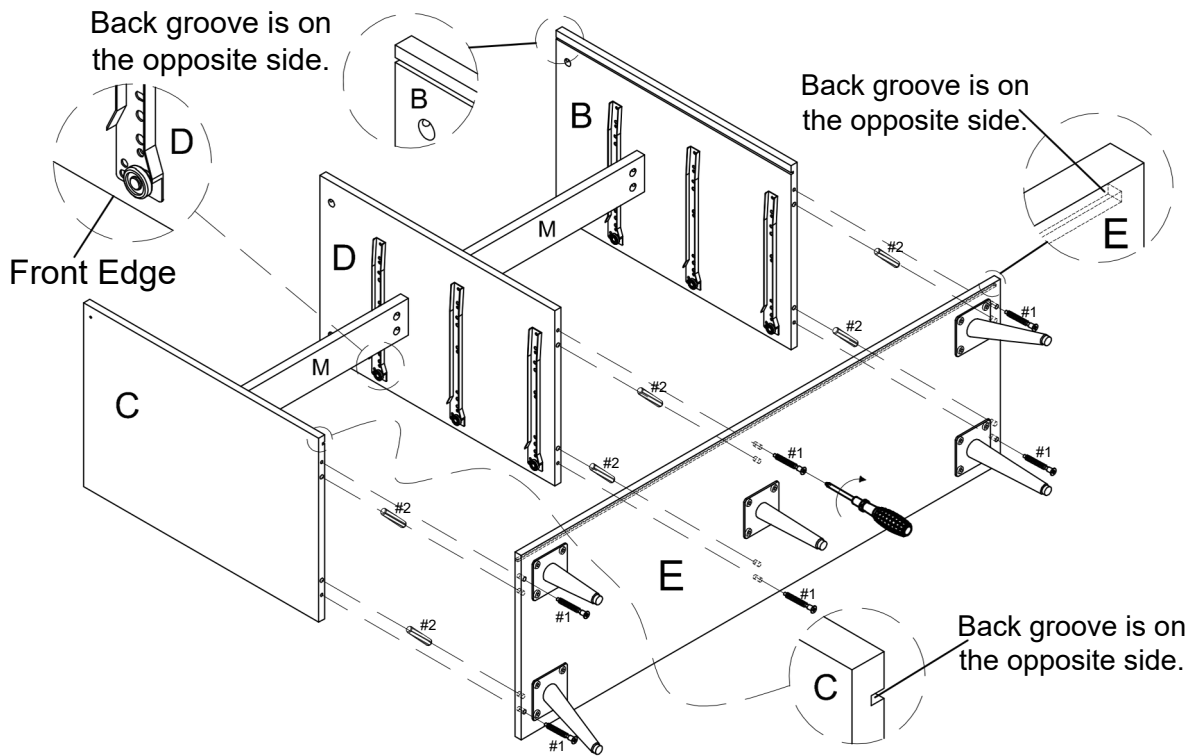
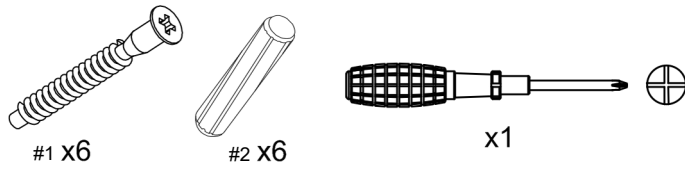

Step 7.

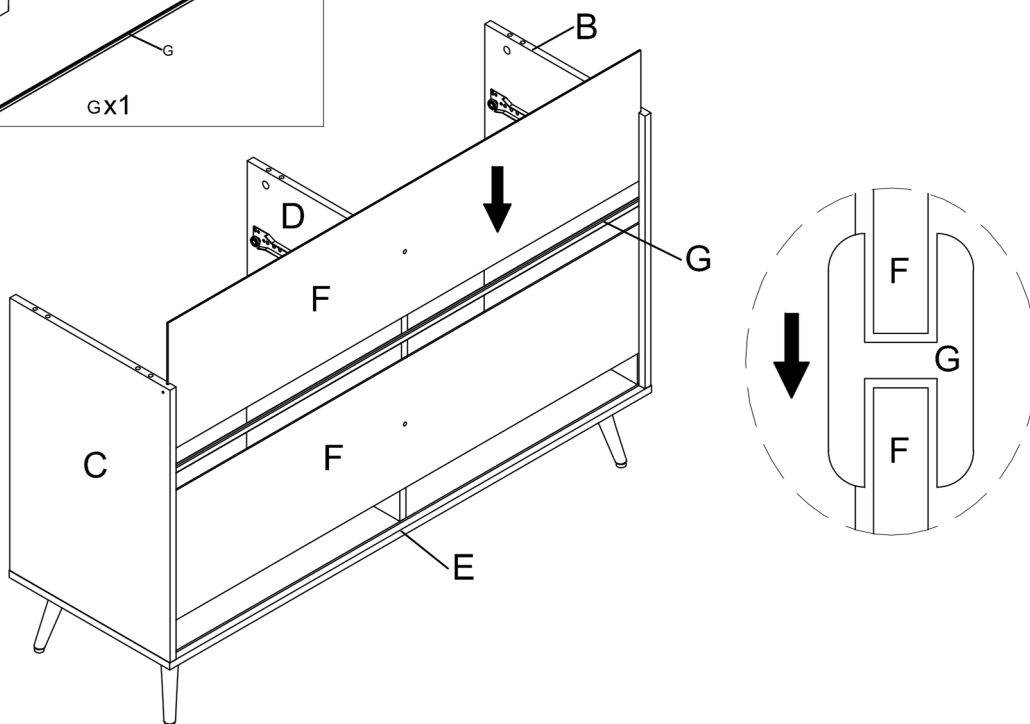
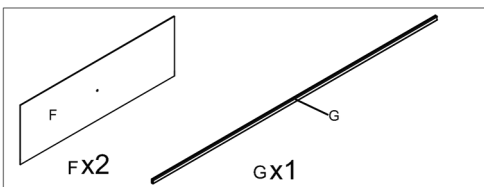

Step 8.

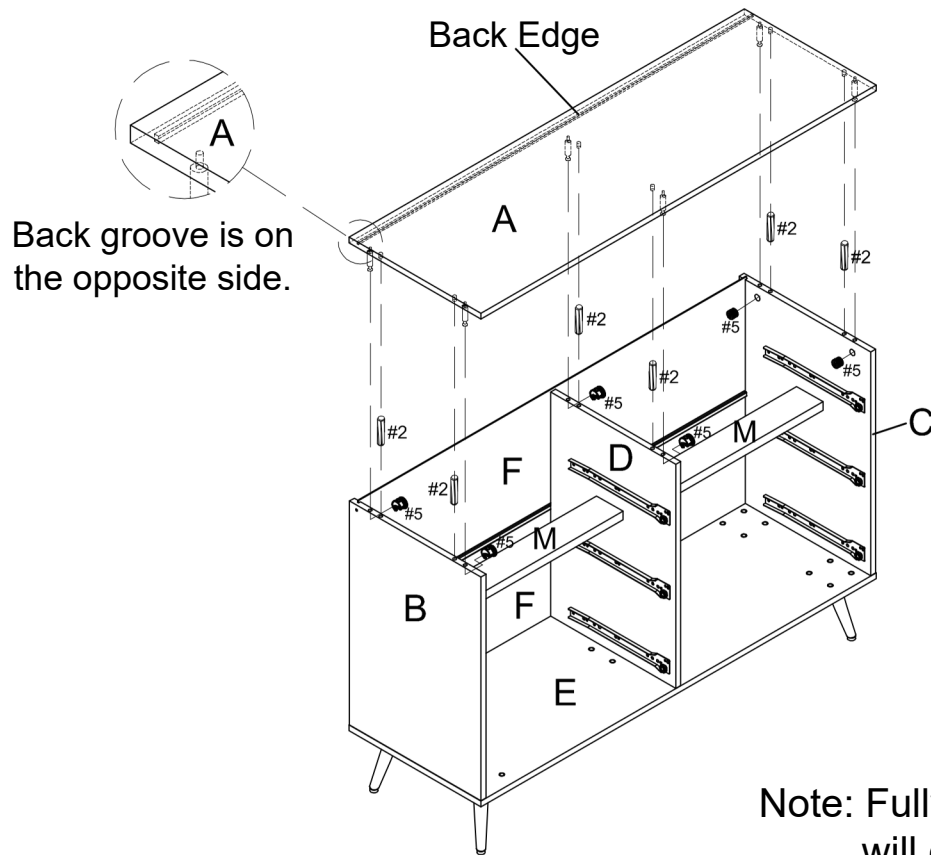
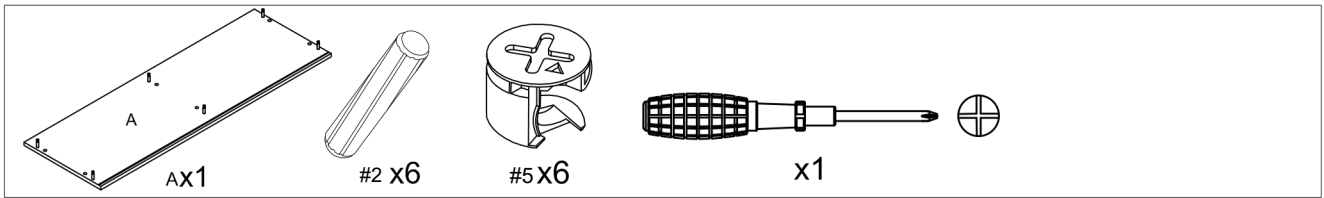

Note: Fully Tighten or it will cause wobble.

Step 9.

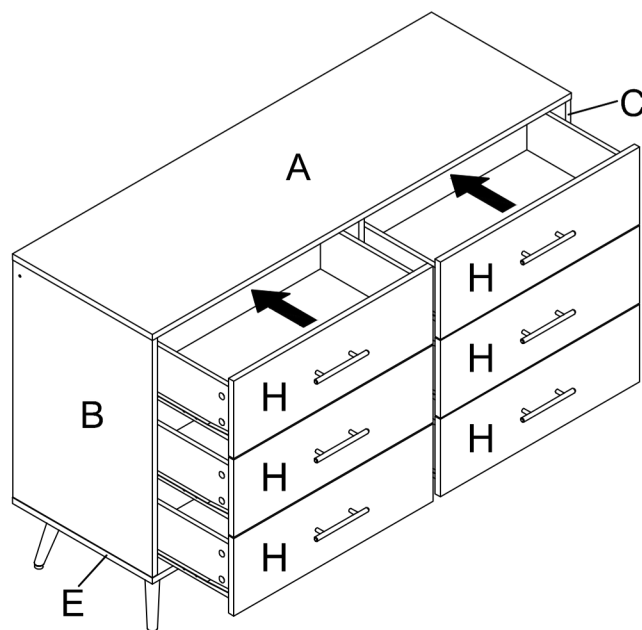
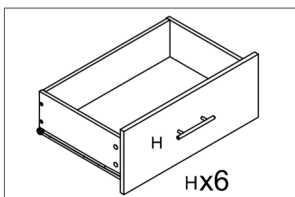

Step 10.

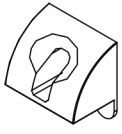

#8 x8





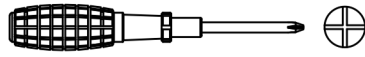

#9 x10

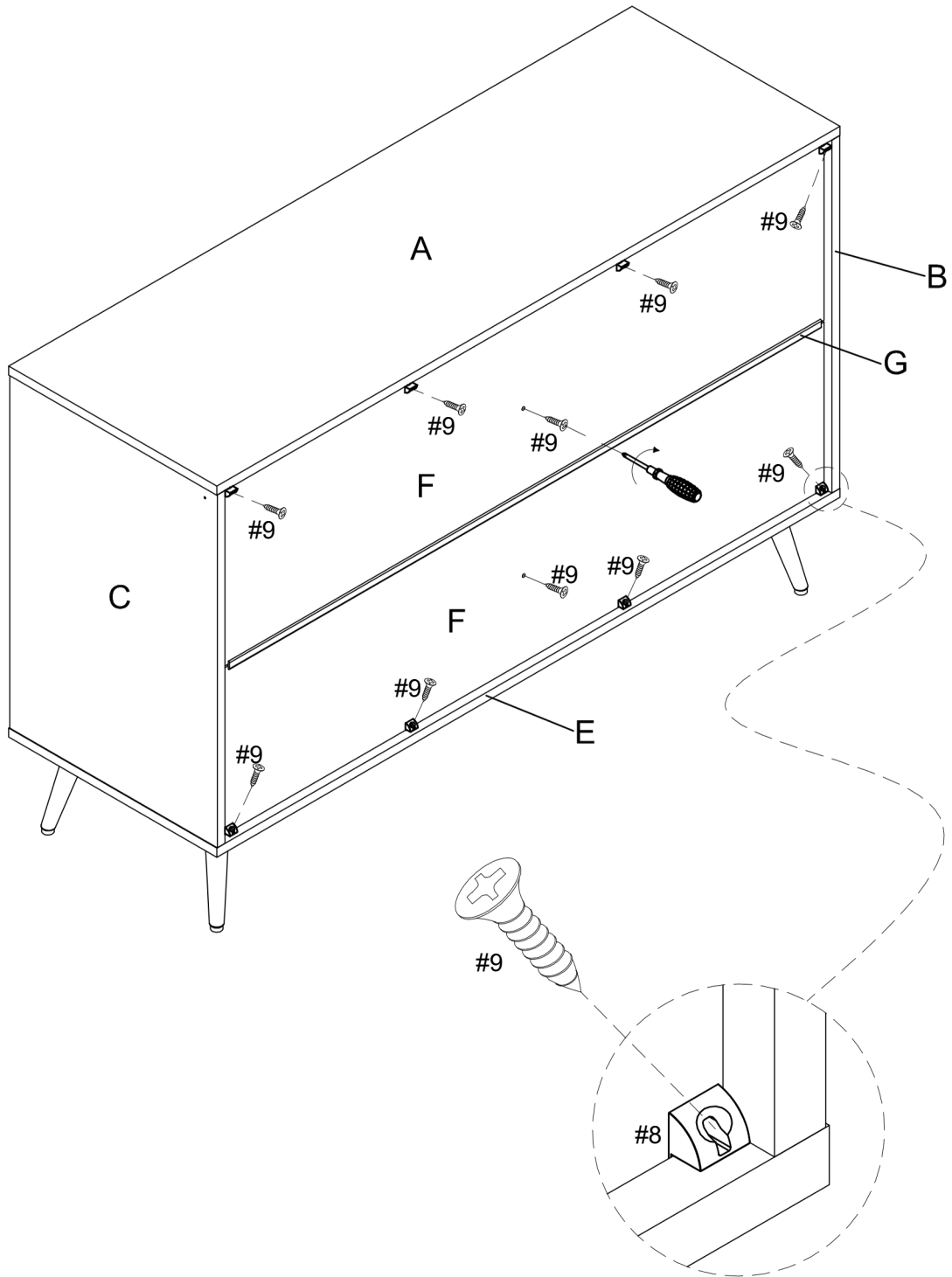

x1

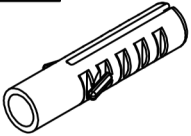

Step 11.

#14		#14-A		#14-B		#14-C		#14-D	
Safety Metal Kit		Angel Iron		Wall Anchor		Ø3.5*15mm Short Screw		Ø4*40mm Long Screw	
1 SET		2 PCS		2 PCS		2 PCS		2 PCS	

SAFETY WALL STRAP INSTALLATION

Note: Safety Metal kit (#14) must be installed to prevent tipping, damage and/or injury.

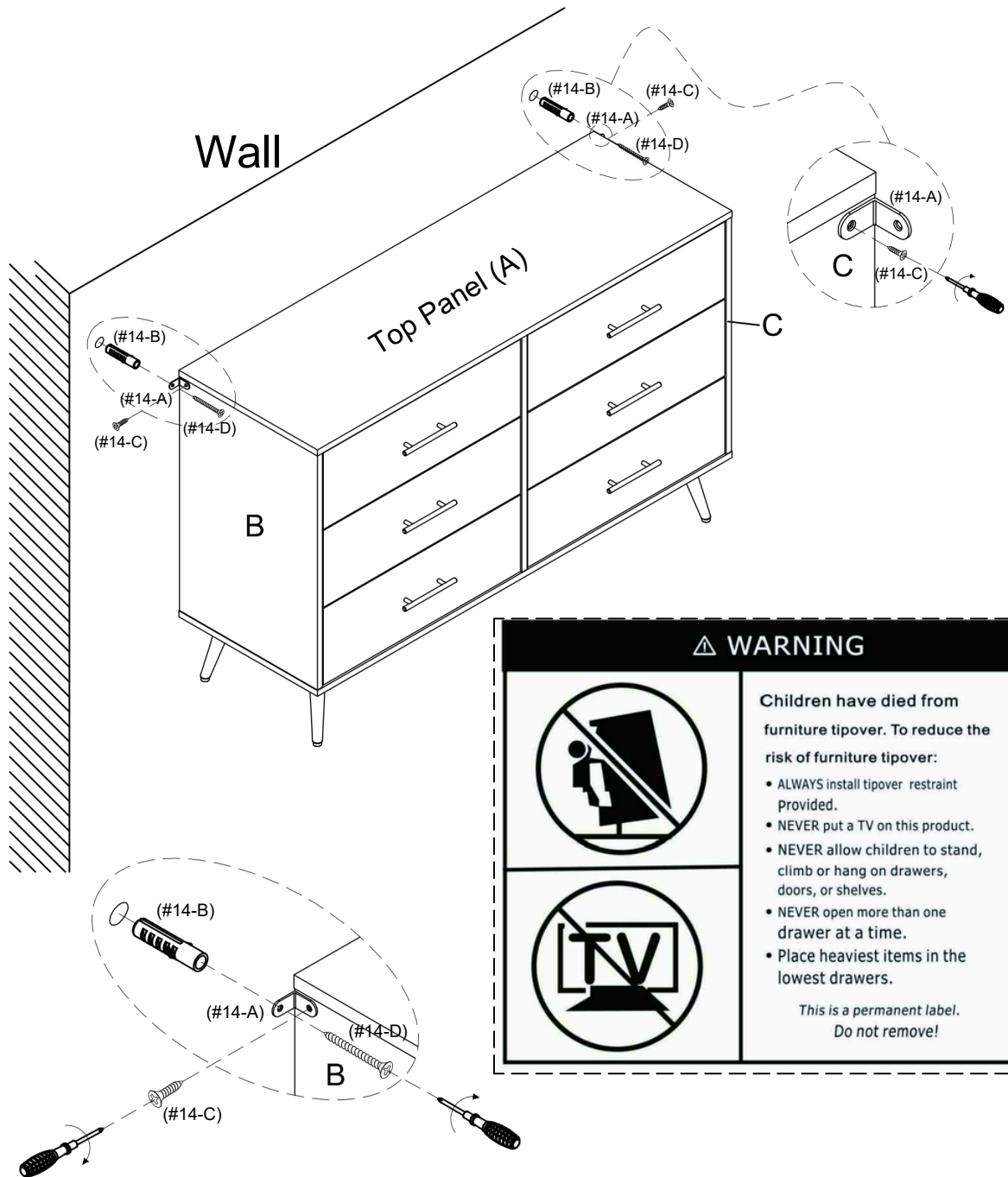

The assembly of the cabinet is complete.

Warning:

Seller is responsible for the product-related issues occurred upon receipt, but will not be responsible for the personal injury, property damage or loss resulting from the incorrect assembly, improper use, inadequate maintenance or neglect of this product.

Notes:

1. ASSEMBLY PREPARATION AND TIPS FOR ASSEMBLY

- 1). Remove all packaging materials, staples and packing straps from the carton.
- 2). Refer to Parts List and Hardware List, and ensure parts and hardware are correct before assembly.
Contact customer service for missing parts.
- 3). Place all wooden parts on a clean, flat and soft surface (e.g. carpet or rug) to prevent scratch and damage to parts.
- 4). Allow ample room for assembly and assemble the product near where the product will be placed.
- 5). During assembly, do not over-tighten any fittings as this may cause damage.
- 6). Always place the product on a flat, level surface.

2. CARE AND MAINTENANCE

- 1). KEEP ALL HARDWARE PARTS OUT OF REACH OF CHILDREN.
- 2). Wipe clean with a soft, dry cloth; avoid the use of harsh chemicals or household cleaners as they may damage the exterior finish of the furniture.
- 3). Hardware may loosen over time. Periodically, check that all connections are tight; re-tighten as necessary.

3. TIPS TO PROTECT & CARE FOR YOUR FURNITURE

- 1). Avoid placing your furniture in direct sunlight, as sunlight causes fading.
- 2). Use a protective pad when writing on the furniture surface.
- 3). Use cutting boards and trivets for food preparation in order to avoid damaging the top for the unit.